

**Kadavra Saklama Odası**

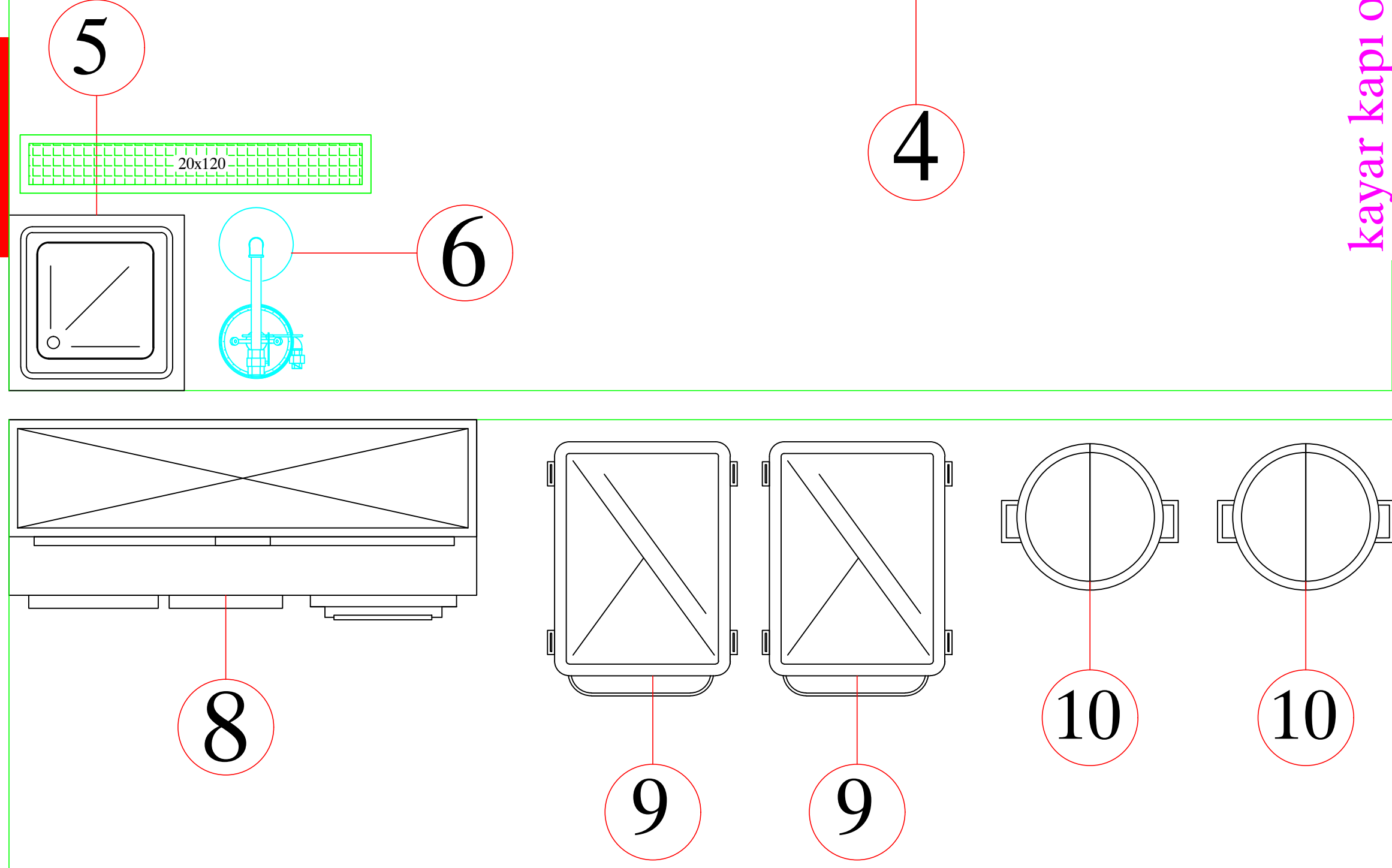

**Diseksiyon Laboratuvarı**

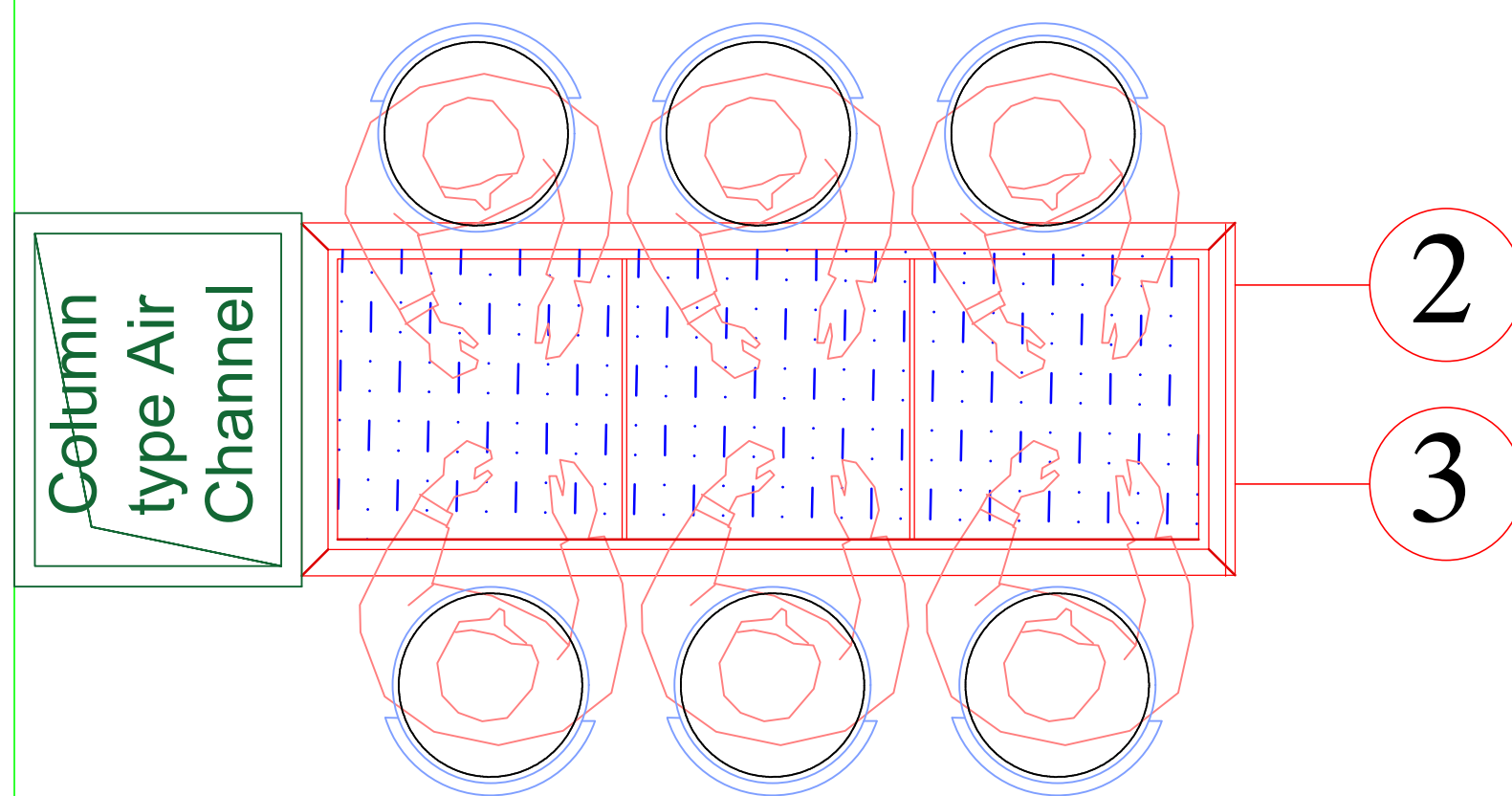
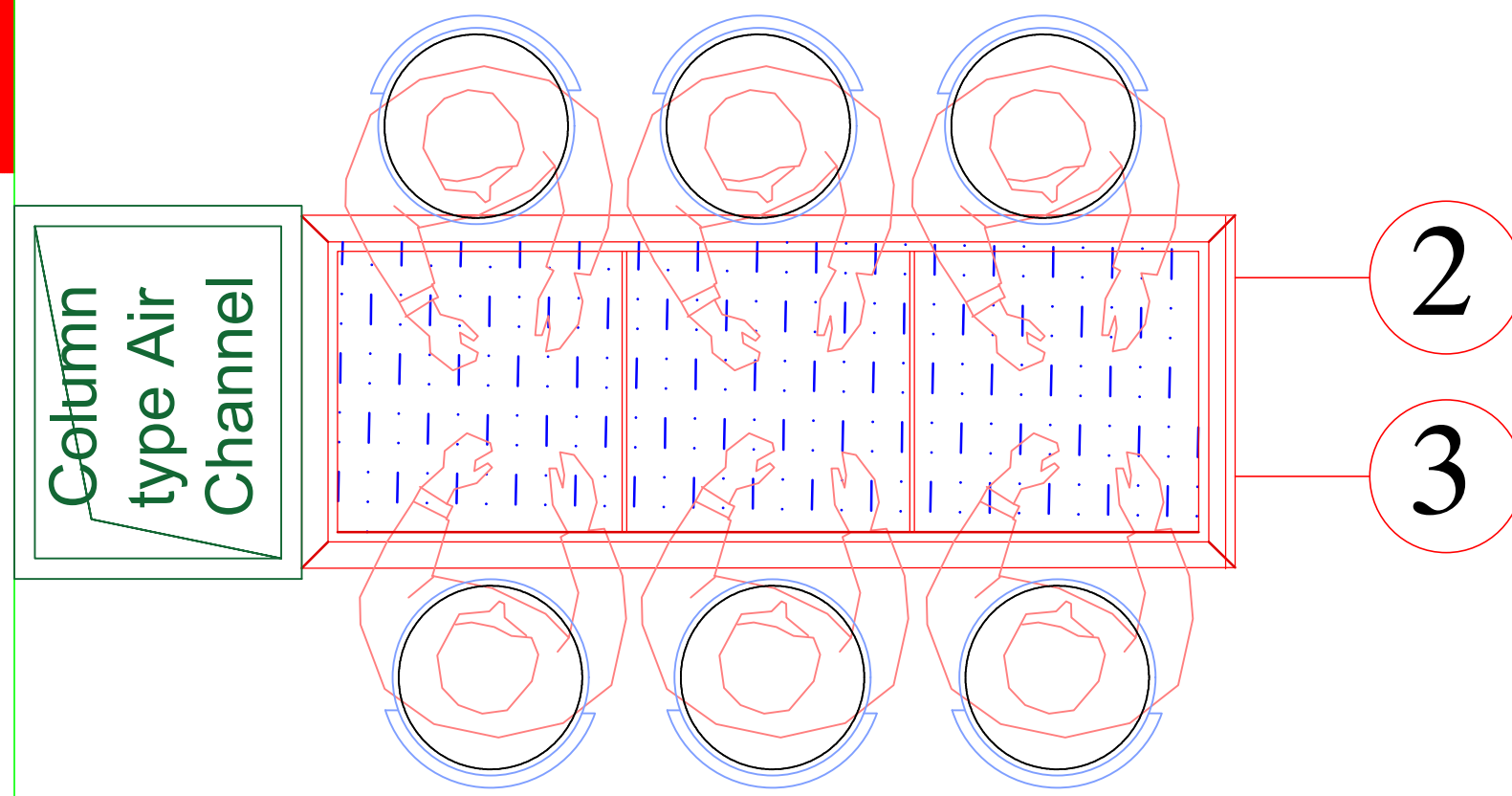
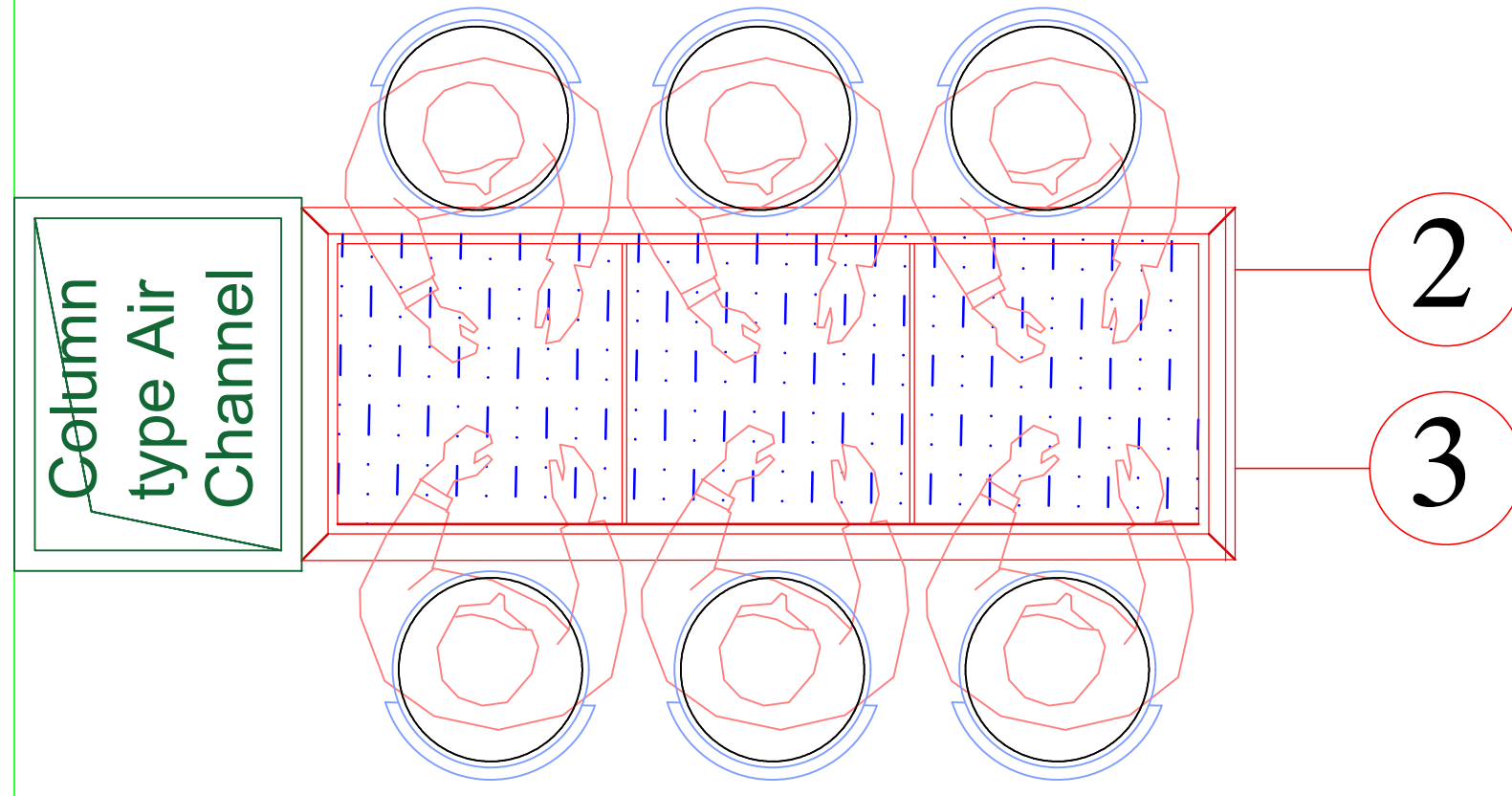

kayar kapı olacaktır.

**Depo**

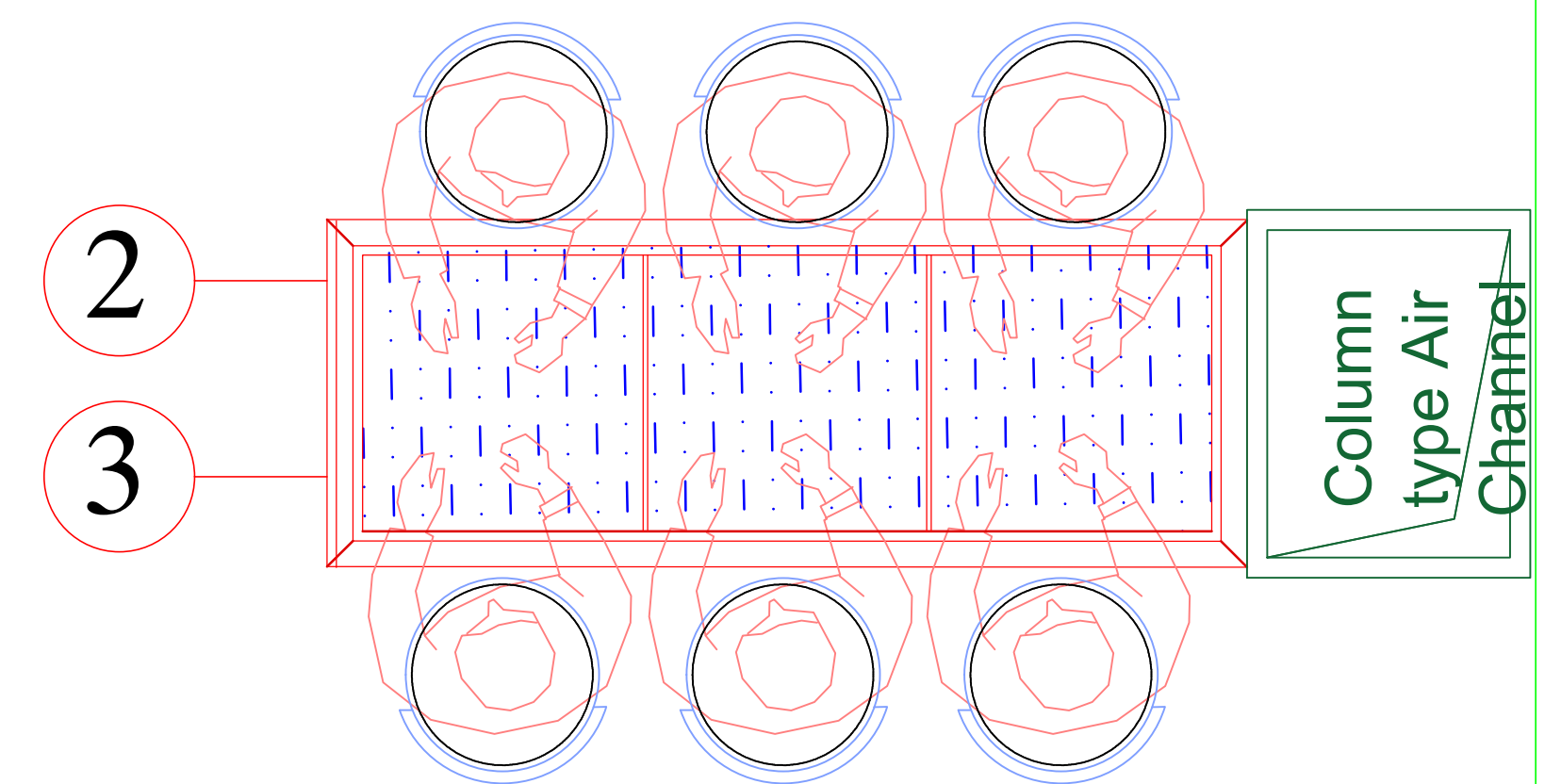
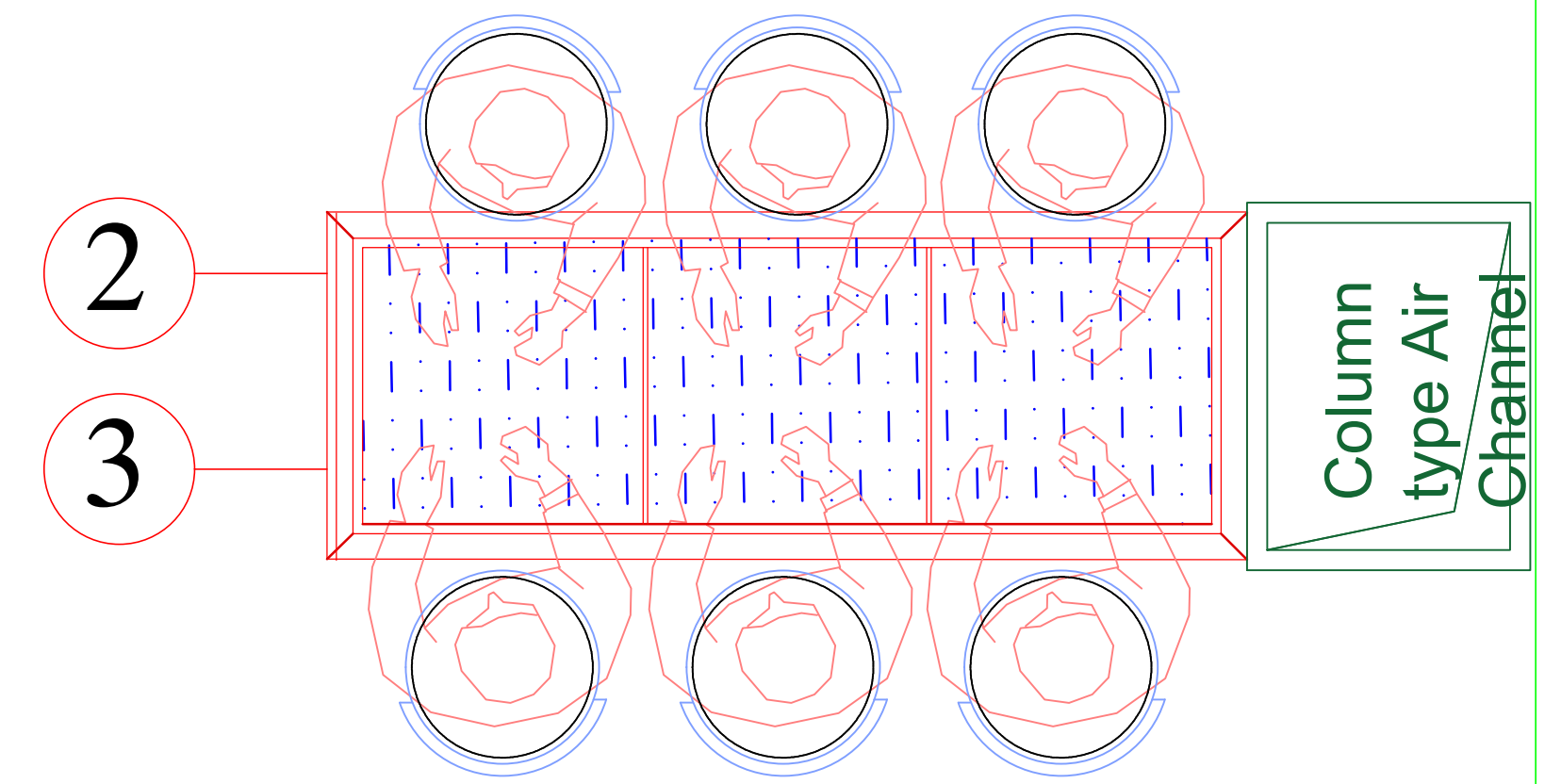
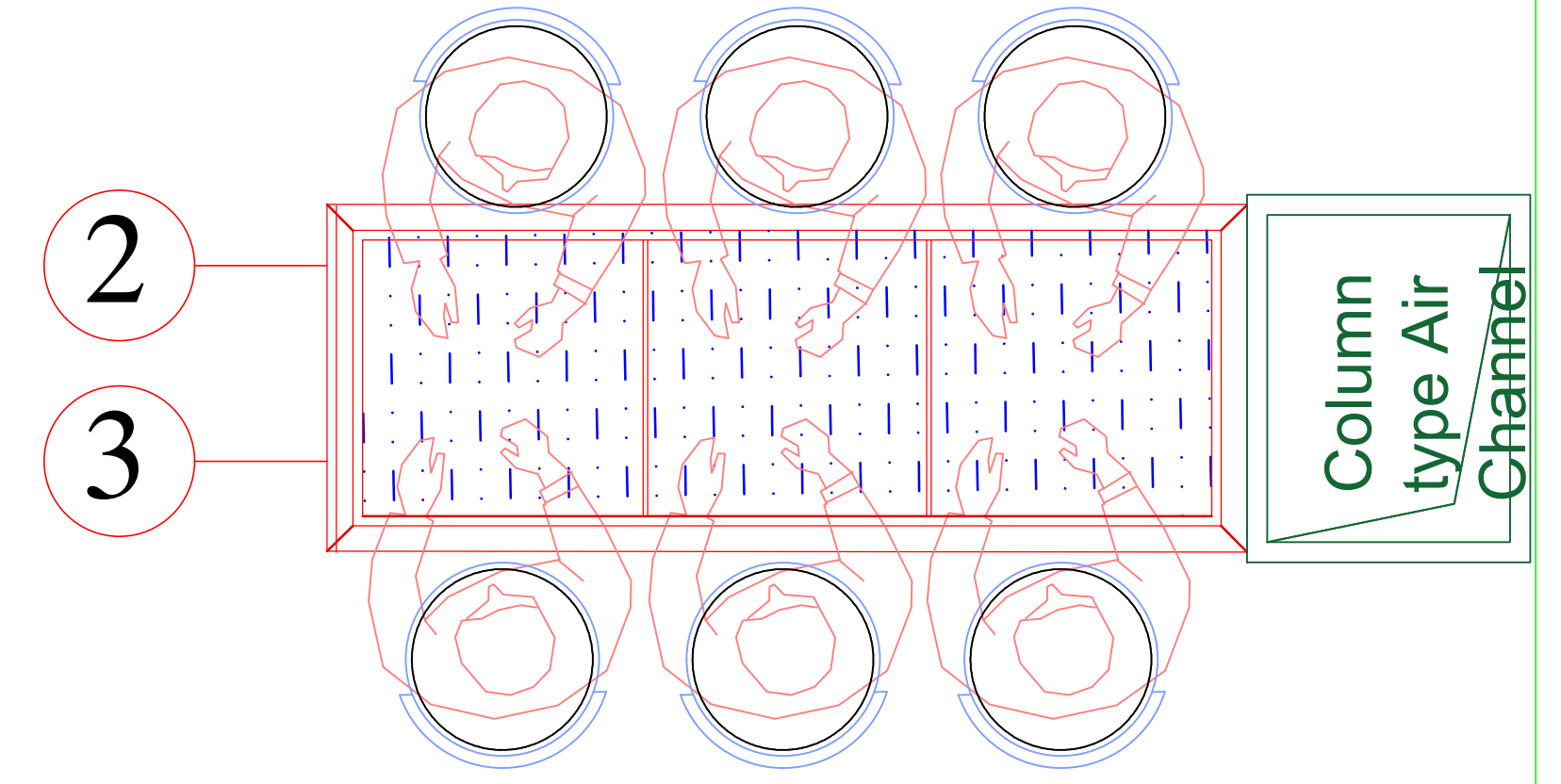
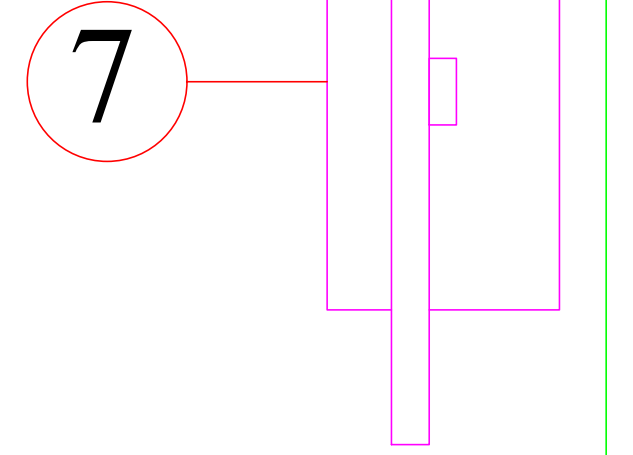
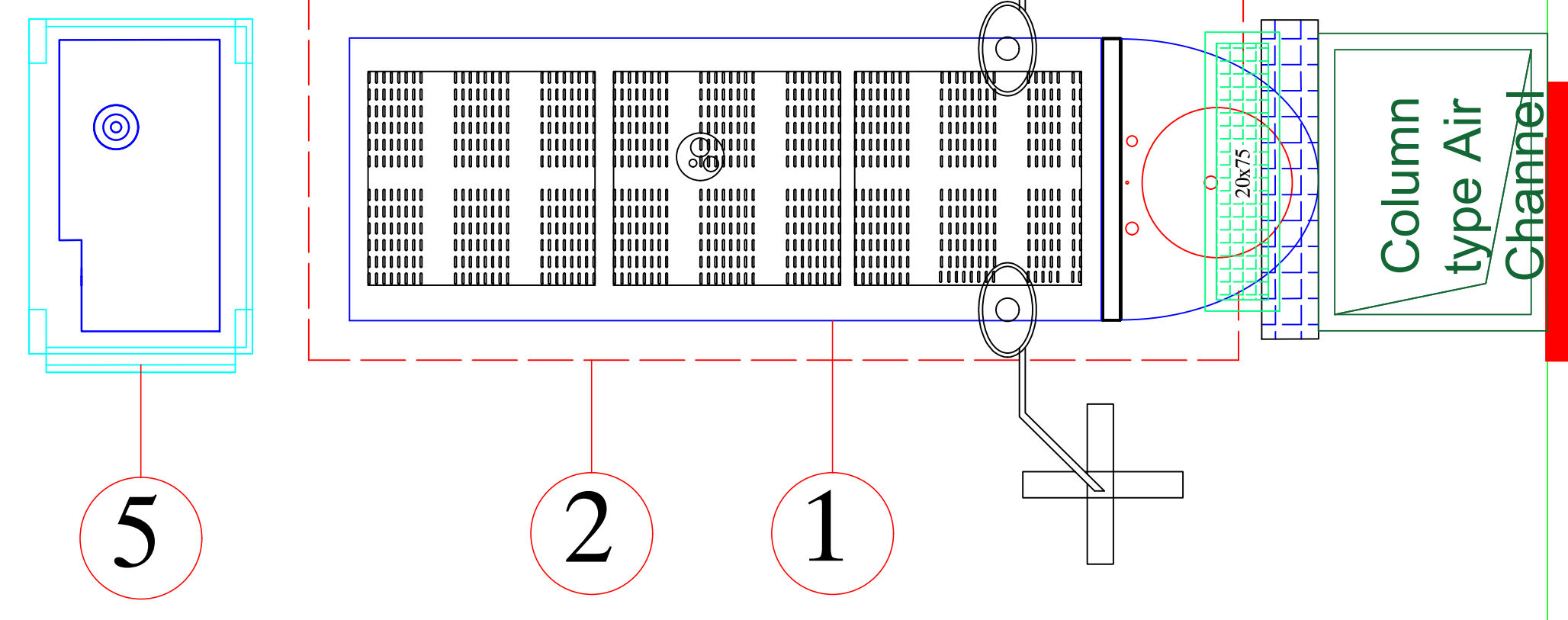
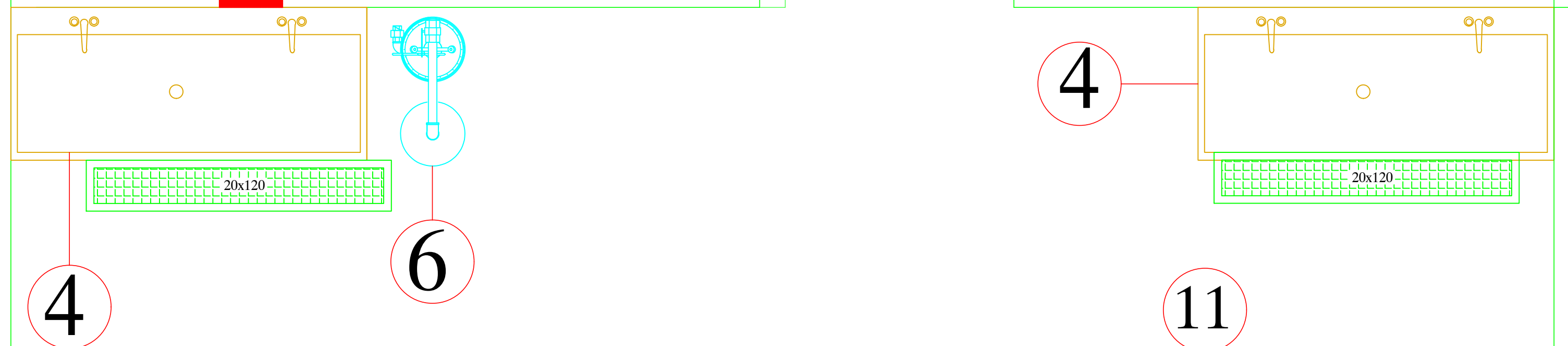
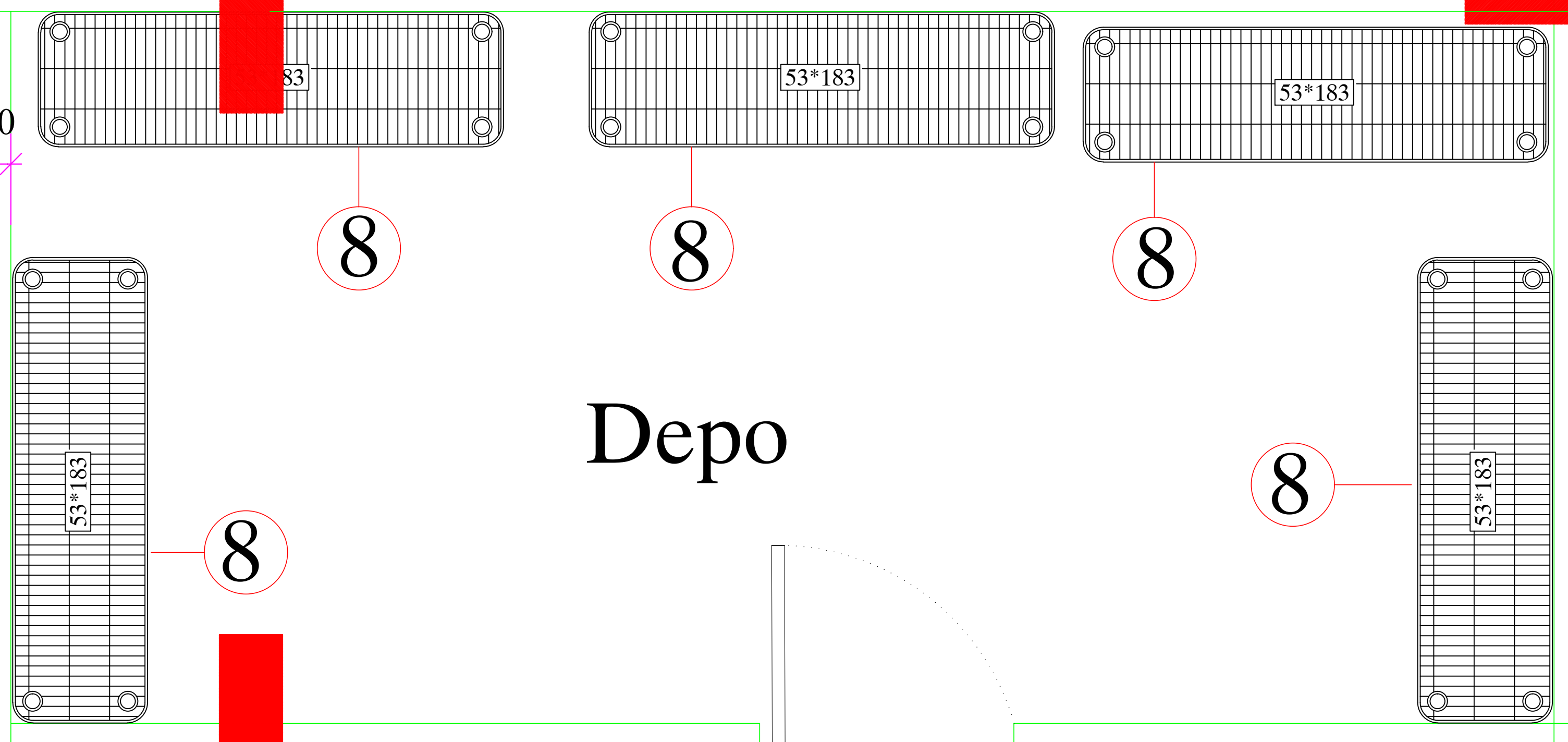

Column type Air Channel

Column type Air Channel

Column type Air Channel

Column type Air Channel